

Helios 600GR

SPECIFICATIONS

ursa

FOR INFORMATION, CONTACT US_
INFO@URSA LIGHTING.COM
TEL: +1 (510) 687-1128
URSA LIGHTING.COM



FEATURES

- Advanced 3-PAD COB LED technology
- Mounting bracket included, mounting hooks optional
- Cold forged heatsink core with patented Forging Fit Technology capable of passively cooling up to 600W
- Designed for greenhouse and commercial applications
- Lighting Footprint : 4'x4'
- Waterproof, full IP65 rating
- Optimal Hang Height: 24 - 36 in.
- Durable surface finish to protect against corrosion and high-humidity environments

01

MECHANICAL SPECIFICATIONS

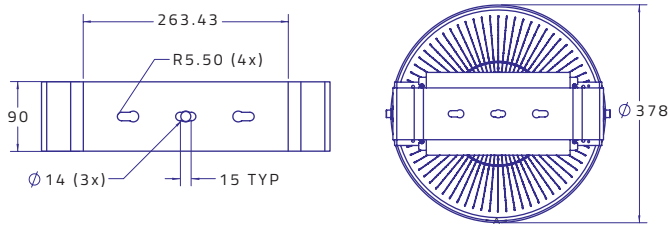
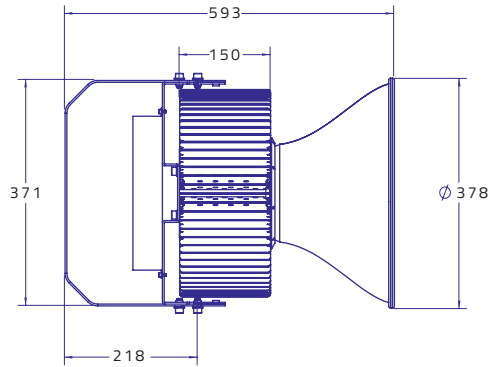

Dimensions (mm) 378 x 371 x 593

Weight 33.1 lbs (15 kg)

Input Voltage 90 - 305 VAC Standard
347V (Option)
480V (Option)

Operation Temperature -20°C to 25°C (-4°F to 77°F)

Material

Heatsink Core Al 1070

Fins Al 1050

Reflector Al 1090

Lens Tempered Glass

Brackets Iron / 304 SS

SPECTRUM GRAPH

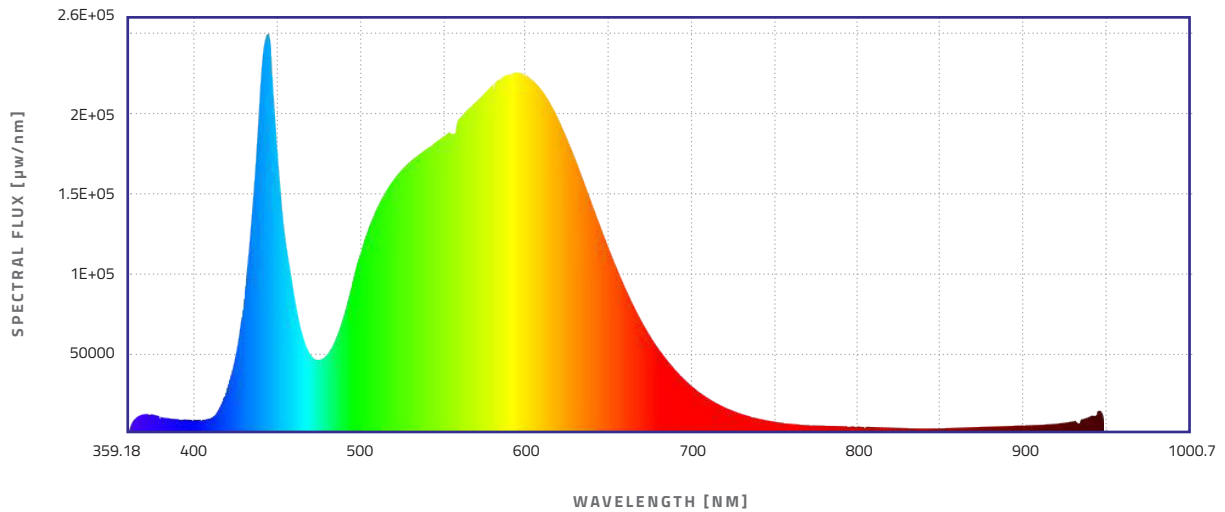

PRODUCT CODE

HS0600A-R604080-THD6

02

PPFD MEASUREMENTS

4' X 4' SINGLE CANOPY DEMONSTRATION

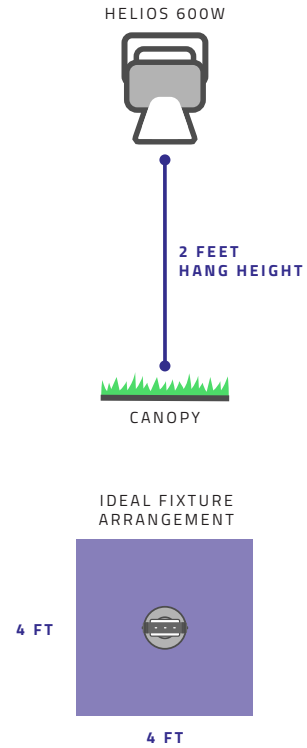
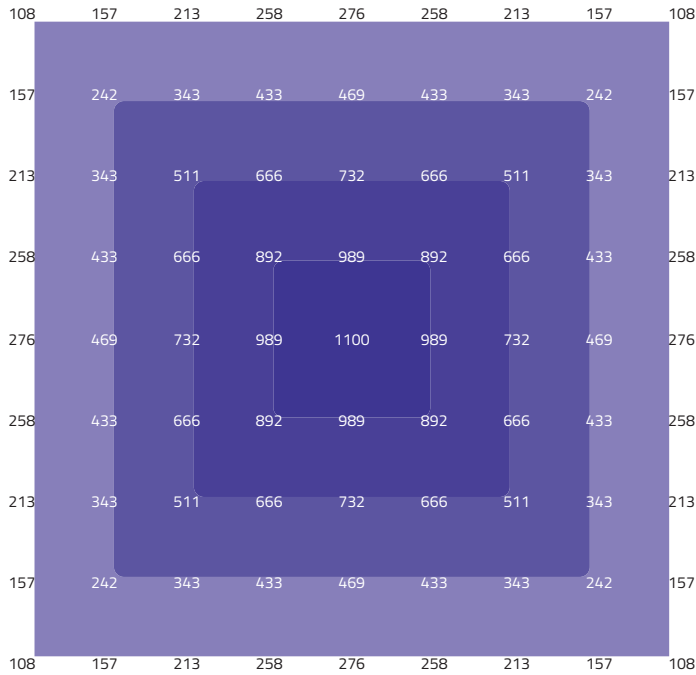

4' X 16' SINGLE-ROW DEMONSTRATION (VERTICAL GROW)

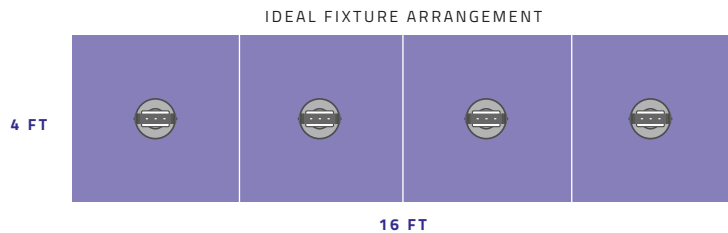
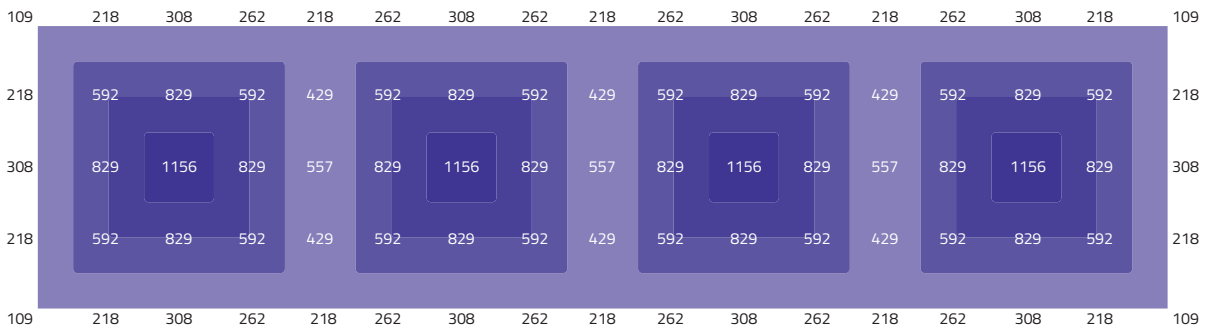

02

PPFD MEASUREMENTS

12' X 16' LARGE CANOPY DEMONSTRATION (COMMERCIAL ROOM)

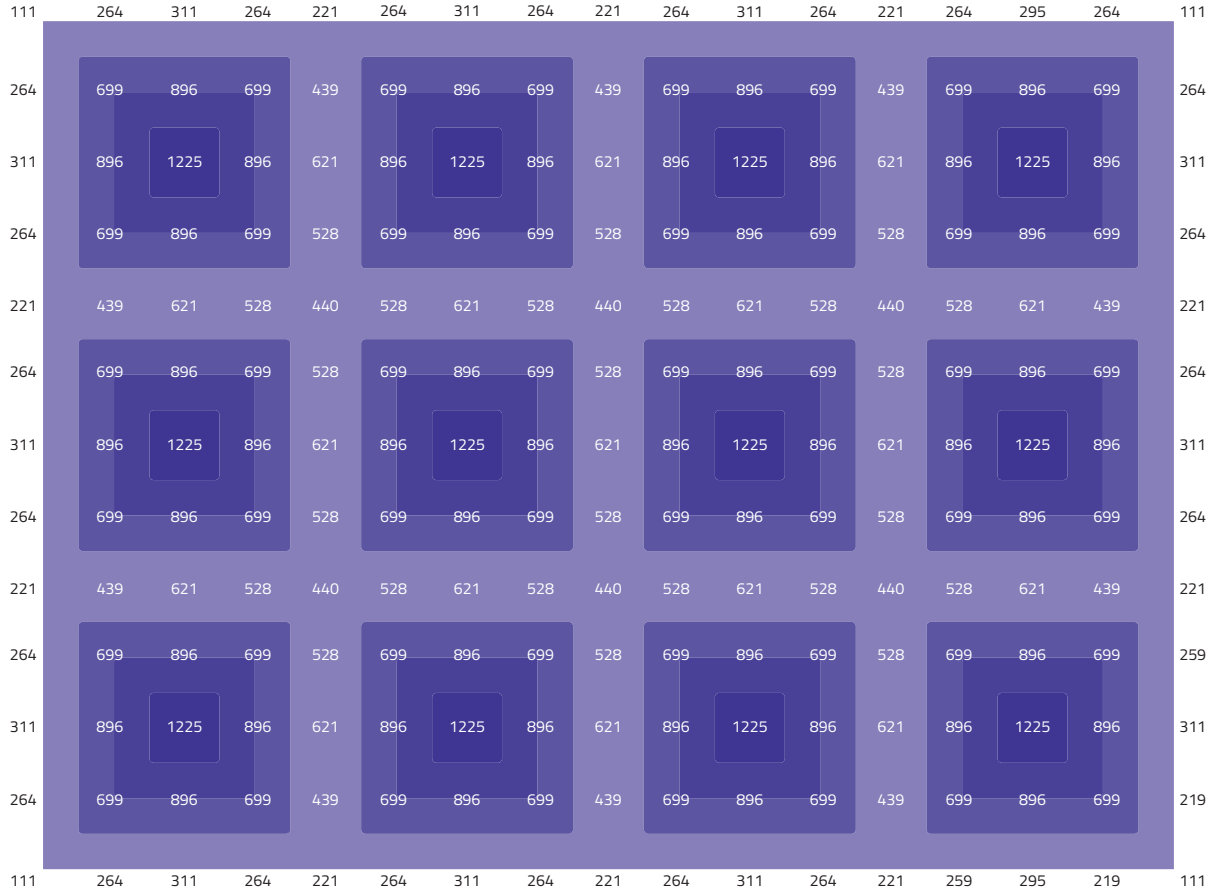

IDEAL FIXTURE ARRANGEMENT

